

SIEMENS

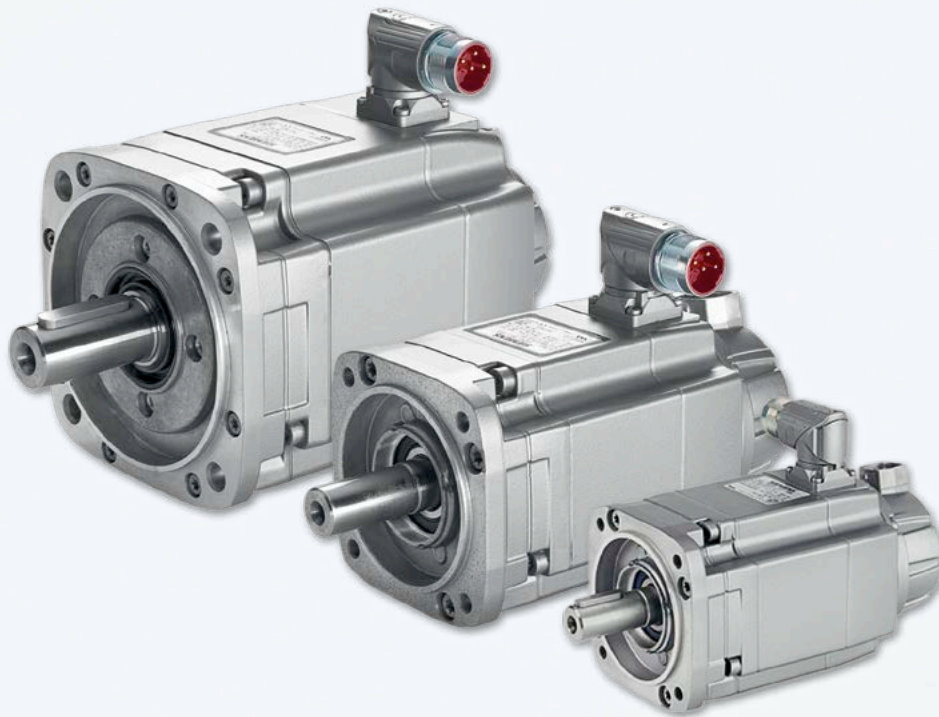

SIMOTICS S-1FK7 Servomotors

Compact Synchronous Motors for Motion Control Applications

Motors

Brochure

Edition
October
2013

Answers for industry.

SIMOTICS Motors for Motion Control Tasks

The right motor for every motion control task

SIMOTICS motors – The right solution for every drive task

Synchronous or asynchronous, with or without a gear unit. When you want the optimum motor for your motion control application, Siemens is the right contact partner for you. We offer the widest range of products worldwide – comprising servomotors, main motors, linear motors and torque motors, as well as motor spindles – impressing customers with their dynamic response and precision.













The requirements for a SIMOTICS servomotor

With the servomotors, Siemens offers a range of synchronous motors that are specially tailored to the requirements of motion control applications.

Excellent dynamic characteristics, high overload capability, compact construction and a high level of ruggedness as well as easy handling are the core characteristics of this motor series.

SIMOTICS S-1FK7 highlights

- Static torques from 0.18 to 48 Nm
- Rated speeds up to 6000 rpm
- Different inertia versions: Standard, High Dynamic, High Inertia
- Up to triple overload capacity
- 10 days delivery time for preferred types
- Innovative encoder system supports quick and easy encoder replacement
- Rotatable connectors with quick-release locks ease connection and cable routing in all mounting positions
- IP64 or IP65 (IP67 as an option for shaft bushing)
- With a choice of absolute encoder, incremental encoder, resolver
- System interface DRIVE-CLiQ to SINAMICS S110 and SINAMICS S120 drive systems with electronic rating plate
- Optionally available with planetary gear, helical gear, bevel gear, offset-shaft and worm gear units

SIMOTICS					
Low-voltage motors for line-fed and converter-fed operation					
General purpose SIMOTICS GP	Severe duty SIMOTICS SD	Explosion-proof SIMOTICS XP	Transnorm SIMOTICS TN	Definite purpose SIMOTICS DP	High torque SIMOTICS HT
					
DC motors		High-voltage motors			
Direct current SIMOTICS DC		High-voltage SIMOTICS HV			
					
Motors for motion control					
SIMOTICS S servomotors	SIMOTICS M main motors		SIMOTICS L linear motors		SIMOTICS T torque motors
					
Servomotors with the highest dynamics and precision characteristics	Main motors with the world's largest performance range and selection flexibility due to their modular design		Linear motors for extreme dynamic performance, peak force, and precision for linear traversing motion		Torque motors with the highest precision through the whole torque range in a highly compact design with rotary axes

Overview of the full SIMOTICS motor portfolio

SIMOTICS – The broadest motor portfolio worldwide. From low-voltage motors, through motors for motion control tasks, all the way to DC and high-voltage motors. With a wide range of performance categories and sizes, you are certain to find the right answer for your specific requirements.

SIMOTICS S-1FK7 Servomotors

The proven standard for motion control tasks

Overview

Available in the torque range from 0.18 to 48 Nm, SIMOTICS S-1FK7 motors are the first choice when motion control applications must be resolved easily and economically.

SIMOTICS S-1FK7 motors are naturally cooled and have a very rugged design with degree of protection IP64 or IP65 (shaft exit optionally IP67).

Because of their cross profile, the motors are quick and easy to install. The new mechanically decoupled encoder system has improved the ruggedness of the system and allows an encoder to be replaced in the shortest possible time. These advantages reduce installation and servicing times considerably.

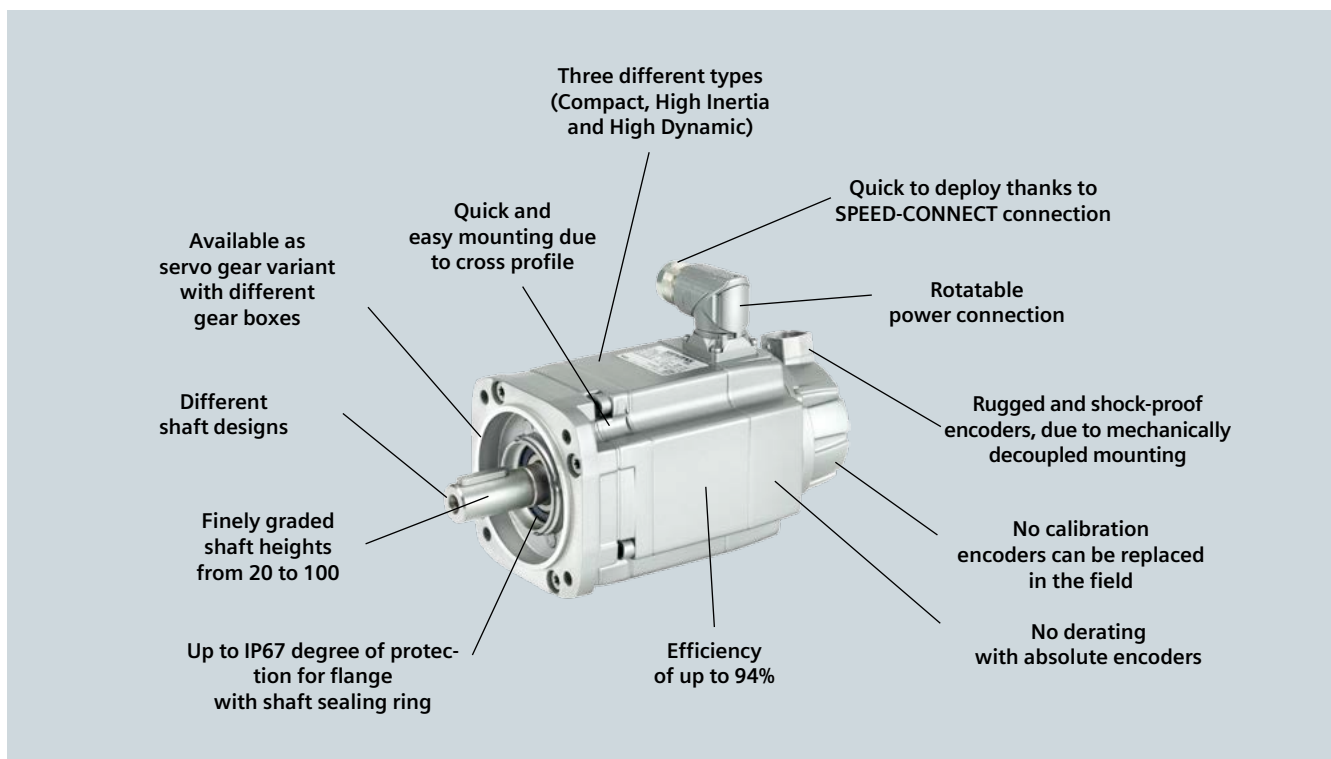

SIMOTICS S-1FK7 Servomotors

The proven standard for motion control tasks

Motor features

Our permanent-magnet SIMOTICS S-1FK7 synchronous motors are available in three versions and thus always provide the fitting solution to your requirements:

- **SIMOTICS S-1FK7 CT motors (Compact):** characterized by their small size and therefore ideally suited to applications in which the installation space is a decisive factor
- **SIMOTICS S-1FK7 HD motors (High Dynamic):** are characterized by their extremely low inertia and are used in applications with very high requirements in terms of dynamics.
- **SIMOTICS S-1FK7 HI motors (High Inertia):** are characterized by their high rotor inertia and are designed for use in feed axes with high or variable load inertia.

Application area

The three different motor designs (Compact, High Inertia and High Dynamic) ensure that SIMOTICS S-1FK7 motors are universally applicable.

In combination with the SINAMICS S drive system, a solution that is found in many motion control applications, such as:

- Robots and handling systems
- Wood, glass, ceramics and stone working machines
- Packaging, plastics and textile machines
- Printing machines
- Auxiliary axes of any type

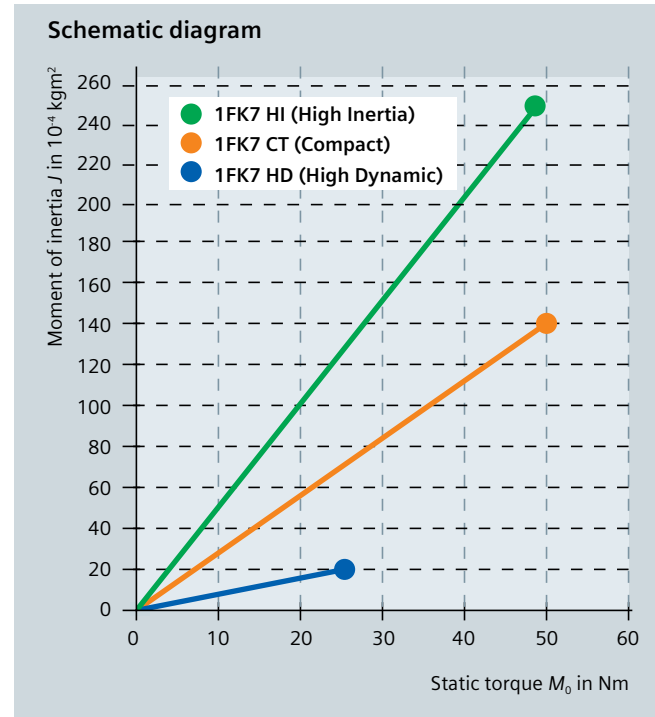

The naturally cooled SIMOTICS S-1FK7 servomotors are ideally suited to highly dynamic and high precision motion sequences. A choice of three versions is available according to the requirements for dynamic response, control response, accuracy and compactness – also in combination with gear units.

SIMOTICS S-1FK7 Servomotors

Always the right choice for your application



SIMOTICS S-1FK7 CT

Compact – for universal application

SIMOTICS S-1FK7 compact motors offer high power density within extremely compact dimensions and are, therefore, the ideal solution for numerous applications. Because of their short overall length, they are predestined to be installed in tight spaces. Their compactness makes them the standard motor in the torque range from 0.18 to 48 Nm. They make motion control axes exceptionally dynamic – thanks to their high overload capability. A motor spectrum is available that comprises 22 types with 7 shaft heights and rated speeds up to 6000 rpm.

To offer quick delivery of the most commonly used SIMOTICS S-1FK7 motors, we are able to deliver a carefully selected range of our motors within 10 working days. The preferred variants for this delivery time are as follows:

- With and without brake
- 20-bit multiturn encoder or 20-bit single-turn encoder
- Shaft extension with or without parallel key
- IP65 degree of protection

(please refer to page 8 for a detailed selection)

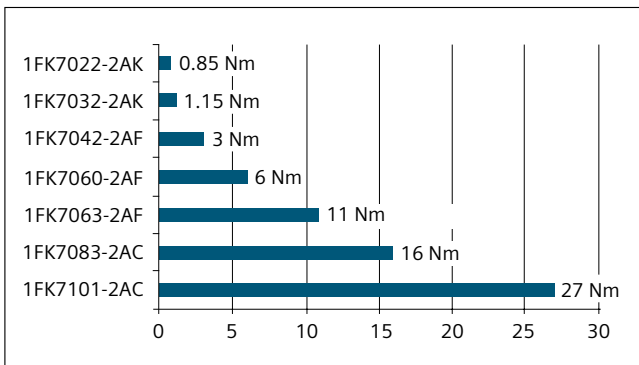

Torque ranges of the preferred types



SIMOTICS S-1FK7 HD

High Dynamic – for maximum acceleration

SIMOTICS S-1FK7 High Dynamic motors are distinguished by a high overload capability as well as low inertia. Thereby, they reach an extremely high acceleration capacity. The SIMOTICS S-1FK7 High Dynamic motors are especially suitable for applications with very short cycle times, e.g. in packaging machines. 14 types are available with a torque range from 1.3 to 28 Nm and rated speeds up to 6000 rpm.



SIMOTICS S-1FK7 HI

High Inertia – for rugged closed-loop control

SIMOTICS S-1FK7 High Inertia motors have a higher rotor inertia than the compact version. With high load inertias, the increased rotor moment of inertia provides for a comfortable control response. The controller default settings are sufficient to ensure a good surface quality on the workpiece when the motor is employed on feed axes with high or variable load inertia. There is a choice of 13 types with 4 shaft heights with torques from 3 to 48 Nm and rated speeds up to 6000 rpm.

SIMOTICS S-1FK7 Servomotors

The proven standard for motion control tasks

Flexible adaptation

SIMOTICS S-1FK7 motors can be perfectly adapted to every application case due to numerous variants and options.

- Single and multiturn encoders in different designs as well as resolvers for SINAMICS drive systems, as well as with EnDat, analog or resolver interfaces
- Optionally with brake
- Degrees of protection IP64, IP65, flange seal to IP67
- Alternative shaft geometry (diameter and length)
- Shaft extension with or without parallel key
- Special colors
- Variant for hazardous areas for dust and gas: Ex-Zone 2 and 22
- Variant with increased resistance to chemicals e.g. to cleaning fluids and disinfectants certified by ECOLAB
- For combination with a wide range of gear units.
- For delivery as a compact planetary geared motor unit with high efficiency. SP+ planetary gear units are available that are ideally suited for high positioning accuracy and highly dynamic cyclic operation, as well as LP+ planetary gear units mounted directly or via a coupling for economical servo engineering.
- For delivery as servo-geared motors with spur, bevel, parallel shaft, or worm gear units.

The type range comprises helical geared motors with 9 gear unit sizes, parallel shaft geared motors with 5 gear unit sizes, bevel geared motors with 8 gear unit sizes and worm geared motors with 5 gear unit sizes.

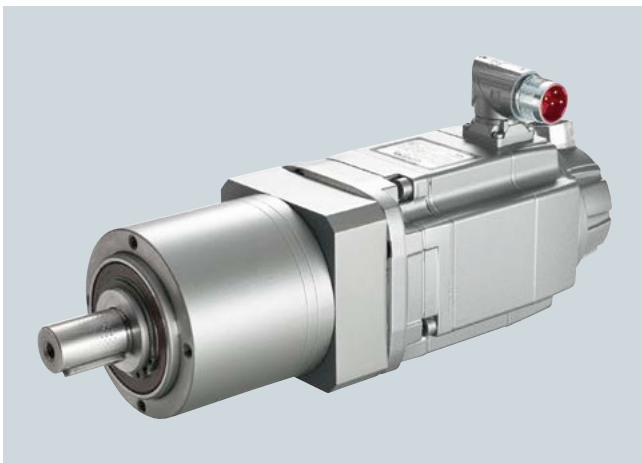

SIMOTICS S-1FK7 motors with LP+ planetary gear box

Perfect interaction with the SINAMICS S110 and SINAMICS S120 drive systems

During development of the SIMOTICS S-1FK7 motors, particular attention was paid to optimum interoperability with the SINAMICS S110 and SINAMICS S120 drive systems.

The perfectly matched power components, electronic rating plate, and motor connection via the DRIVE-CLiQ system interface ensure fast commissioning and smooth operation.

The field weakening function expands the usable speed range of the motors.

Preassembled MOTION-CONNECT signal and power cables support the easy and error-free connection of components.

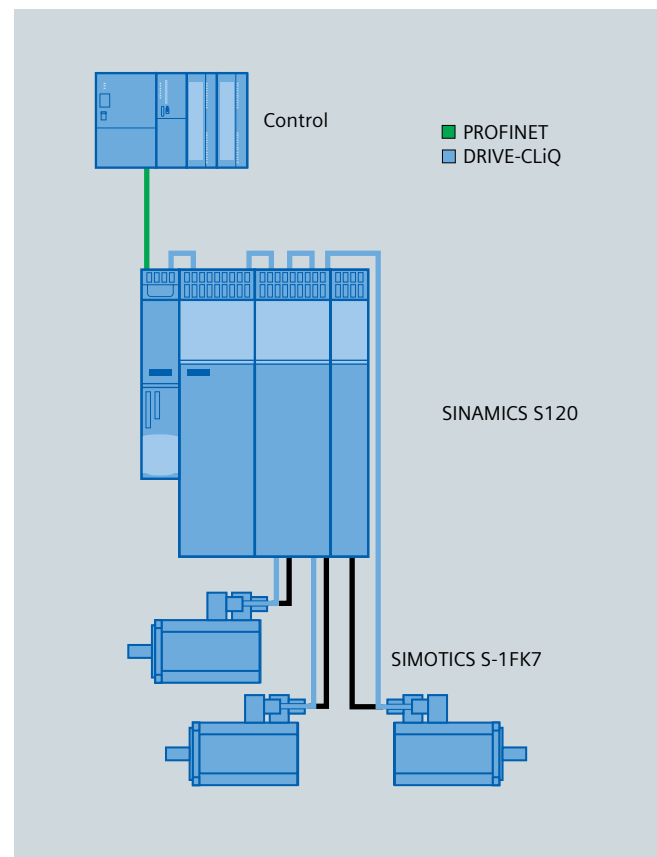

Integrating SIMOTICS S-1FK7 motors in the SINAMICS S120 drive system

SIMOTICS S-1FK7 Servomotors

User-friendly tools for dimensioning and design

Configuration tool SIZER for Siemens Drives

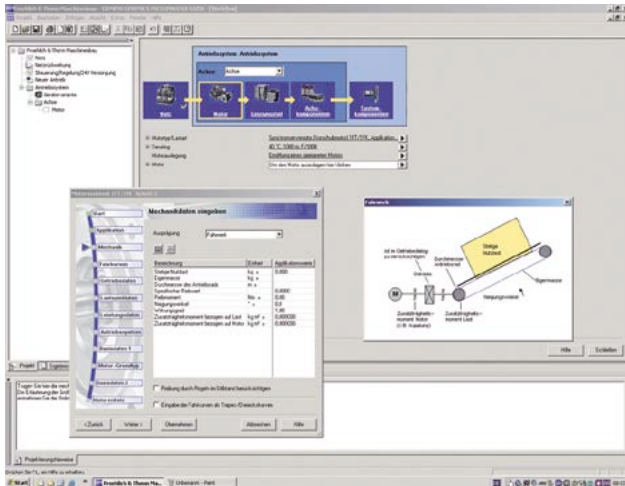

SIZER: Confident dimensioning of motors with the motor wizard

SIMOTICS S-1FK7 motors are dimensioned easily and reliably using the configuration tool SIZER for Siemens Drives.

SIZER guides the user directly to the right motor on the basis of the entered mechanical data and process data for the application. In addition to the electrical data of the motor, SIZER also provides an interface to CAD CREATOR, the tool for dimension sheets and CAD data for simple mechanical integration of the motor.

For further information on the configuration tool SIZER for Siemens Drives, visit:
www.siemens.com/sizer

CAD CREATOR – for dimension sheet and 2D/3D CAD data

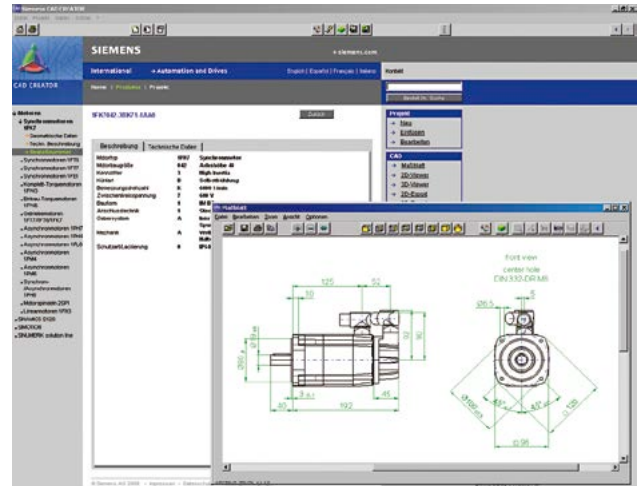

CAD CREATOR:
Easy and fast access to dimension sheets and CAD data

Using the tool CAD CREATOR, dimension sheets and CAD data for SIMOTICS S-1FK7 motors can be generated quickly and easily to be used, for example, in the design and equipment documentation.

CAD CREATOR is included in the scope of supply of SIZER, or is available separately online or on DVD.

For further information, visit:

www.siemens.com/cad-creator

More information can be found on the Internet at:

www.siemens.com/industrymall

SIMOTICS S-1FK7 for 300 V DC link voltage

SIMOTICS S-1FK7 servo motors, naturally cooled	Shaft height	Rated speed	Static torque	Stall current	Rated torque	Rated current	Rotor moment of inertia without brake	Converter	
								Rated output current	SINAMICS S120 Motor Module Booksize format *)
Type	SH	n_{rated} rpm	M_0 $\Delta T = 100$ K Nm	I_0 $\Delta T = 100$ K A	M_{rated} Nm	I_{rated} A	J kgm ²	I_{rated} A	
SIMOTICS S-1FK7 CT (Compact)									
1FK7011-5AK2	20	6,000	0.18	0.85	0.08	0.5	0.0064	0.9	6SL3120-1TE13-0AA3
1FK7015-5AK2	20	6,000	0.35	0.85	0.16	0.5	0.083	0.9	6SL3120-1TE13-0AA3
1FK7022-5AK2	28	6,000	0.85	1.8	0.6	1.4	0.28	2.3	6SL3120-1TE13-0AA3
1FK7032-2AF2	36	3,000	1.15	1.7	1.0	1.6	0.65	2.3	6SL3210-1SB12-3UA3
1FK7034-2AF2	36	3,000	1.6	1.9	1.45	1.8	0.9	2.3	6SL3210-1SB12-3UA3
1FK7042-2AF2	48	3,000	3	3.95	2.6	3.5	2.9	3.9	6SL3210-1SB14-0UA3
SIMOTICS S-1FK7 HD (High Dynamic)									
1FK7033-4CF2	36	3,000	1.3	2.1	1.2	2.05	0.25	2.3	6SL3210-1SB12-3UA3
1FK7043-4CF2	48	3,000	3.3	3.9	3	3.7	1	3.9	6SL3210-1SB14-0UA3

Technical specifications

SIMOTICS S-1FK7 for 600 V DC link voltage

SIMOTICS S-1FK7 servo motors, naturally cooled	Shaft height	Rated speed	Static torque	Stall current	Rated torque	Rated current	Rotor- moment of inertia without brake	Converter	
								Rated output current	SINAMICS S120 Motor Module Booksiz format *)
Type	SH	n_{rated} rpm	M_0 $\Delta T = 100$ K Nm	I_0 $\Delta T = 100$ K A	M_{rated} Nm	I_{rated} A	J kgm ²	I_{rated} A	
SIMOTICS S-1FK7 CT (Compact)									
1FK7011-5AK7	20	6,000	0.18	1.5	0.08	0.85	0.064	3	6SL3120-1TE13-0AA3
1FK7015-5AK7	20	6,000	0.35	1.5	0.16	0.85	0.083	3	6SL3120-1TE13-0AA3
1FK7022-5AK7**)	28	6,000	0.85	1.8	0.6	1.4	0.28	3	6SL3120-1TE13-0AA3
1FK7032-2AK7**)	36	6,000	1.15	1.7	0.8	1.3	0.65	3	6SL3120-1TE13-0AA3
1FK7034-2AK7	36	6,000	1.6	1.9	1	1.3	0.9	3	6SL3120-1TE13-0AA3
1FK7040-2AK7	48	6,000	1.6	2.35	1.1	1.85	1.6	3	6SL3120-1TE13-0AA3
1FK7042-2AC7	48	2,000	3	1.6	2.8	1.55	2.9	3	6SL3120-1TE13-0AA3
1FK7042-2AF7**)	48	3,000	3	2.2	2.6	2	2.9	3	6SL3120-1TE13-0AA3
1FK7042-2AK7	48	6,000	3	4.4	1.5	2.5	2.9	5	6SL3120-1TE15-0AA3
1FK7060-2AC7	63	2,000	6	3.15	5.3	2.95	7.7	5	6SL3120-1TE15-0AA3
1FK7060-2AF7**)	63	3,000	6	4.45	4.7	3.7	7.7	5	6SL3120-1TE15-0AA3
1FK7060-2AH7	63	4,500	6	6.3	3.7	4.3	7.7	9	6SL3120-1TE21-0AA3
1FK7062-2AC7	63	2,000	8.5	3	7	2.65	11.2	3	6SL3120-1TE13-0AA3
1FK7062-2AF7	63	3,000	8.5	5.3	6	4	11.2	9	6SL3120-1TE21-0AA3
1FK7062-2AH7	63	4,500	8.5	8	3	3.3	11.2	9	6SL3120-1TE21-0AA3
1FK7063-2AC7	63	2,000	11	5.3	8.9	4.4	14.7	9	6SL3120-1TE21-0AA3
1FK7063-2AF7**)	63	3,000	11	8	7.3	5.6	14.7	9	6SL3120-1TE21-0AA3
1FK7063-2AH7	63	4,500	11	12	3	3.8	14.7	18	6SL3120-1TE21-8AA3
1FK7080-2AF7	80	3,000	8	4.9	6.8	4.4	14.2	5	6SL3120-1TE15-0AA3
1FK7080-2AH7	80	4,500	8	7.4	4.5	4.8	14.2	9	6SL3120-1TE21-0AA3
1FK7081-2AC7	80	2,000	12	5	10	4.4	20	5	6SL3120-1TE15-0AA3
1FK7081-2AF7	80	3,000	12	8.7	8.7	6.8	20	9	6SL3120-1TE21-0AA3
1FK7081-2AH7	80	4,500	12	13.1	3.8	4.9	20	18	6SL3120-1TE21-8AA3
1FK7083-2AC7**)	80	2,000	16	7.5	12.5	6.3	26	9	6SL3120-1TE21-0AA3
1FK7083-2AF7	80	3,000	16	10.1	10.5	7.2	26	18	6SL3120-1TE21-8AA3
1FK7083-2AH7	80	4,500	16	15	3	3.6	26	18	6SL3120-1TE21-8AA3
1FK7084-2AC7	80	2,000	20	8.5	15	6.7	32.5	9	6SL3120-1TE21-0AA3
1FK7084-2AF7	80	3,000	20	12.1	10	6.5	32.5	18	6SL3120-1TE21-8AA3
1FK7100-2AC7	100	2,000	18	8.4	14.5	7.1	54	9	6SL3120-1TE21-0AA3
1FK7100-2AF7	100	3,000	18	11.1	12	8	54	18	6SL3120-1TE21-8AA3
1FK7101-2AC7**)	100	2,000	27	12.3	20.5	9.7	79	18	6SL3120-1TE21-8AA3
1FK7101-2AF7	100	3,000	27	18.8	15.5	11.6	79	30	6SL3120-1TE23-0AA3
1FK7103-2AC7	100	2,000	36	14.4	25	11	104	18	6SL3120-1TE21-8AA3
1FK7103-2AF7	100	3,000	36	26	14	11.5	104	30	6SL3120-1TE23-0AA3
1FK7105-2AC7	100	2,000	48	20	37	16	154	30	6SL3120-1TE23-0AA3
1FK7105-2AF7	100	3,000	48	31	26	18	154	45	6SL3120-1TE24-5AA3
SIMOTICS S-1FK7 HD (High Dynamic)									
1FK7033-4CK7	36	6,000	1.3	2.1	0.9	1.6	0.25	3	6SL3120-1TE13-0AA3
1FK7043-4CH7	48	4,500	3.5	4.1	2.6	3.3	1	5	6SL3120-1TE15-0AA3
1FK7043-4CK7	48	6,000	3.5	5.6	2	3.5	1	9	6SL3120-1TE21-0AA3
1FK7044-4CF7	48	3,000	4.5	4	3.7	3.45	1.26	5	6SL3120-1TE15-0AA3
1FK7044-4CH7	48	4,500	4.5	5.4	3	3.9	1.26	9	6SL3120-1TE21-0AA3
1FK7061-4CF7	63	3,000	6.4	6.1	5.4	5.3	4.1	9	6SL3120-1TE21-0AA3
1FK7061-4CH7	63	4,500	6.4	8.7	4.3	6.2	4.1	9	6SL3120-1TE21-0AA3
1FK7064-4CC7	63	2,000	12	8.1	10	7.1	7.5	9	6SL3120-1TE21-0AA3
1FK7064-4CF7	63	3,000	12	10.8	8	7.6	7.5	18	6SL3120-1TE21-8AA3
1FK7064-4CH7	63	4,500	12	15	5	7	7.5	18	6SL3120-1TE21-8AA3
1FK7085-4CC7	80	2,000	22	13.5	15	10	22	18	6SL3120-1TE21-8AA3
1FK7085-4CF7	80	3,000	22	22	6.5	7	22	30	6SL3120-1TE23-0AA3
1FK7086-4CC7	80	2,000	28	13.2	18	9	22	18	6SL3120-1TE21-8AA3
1FK7086-4CF7	80	3,000	28	21.5	6.5	5.7	22	30	6SL3120-1TE23-0AA3
SIMOTICS S-1FK7 HI (High Inertia)									
1FK7042-3BK7	48	6,000	3	4.4	1.5	2.5	5.1	5	6SL3120-1TE15-0AA3
1FK7060-3BF7	63	3,000	6	4.45	4.7	3.7	12.5	5	6SL3120-1TE15-0AA3
1FK7062-3BF7	63	3,000	8.5	5.3	6	4	23.5	9	6SL3120-1TE21-0AA3
1FK7081-3BF7	80	3,000	12	8.7	8.7	6.8	49	9	6SL3120-1TE21-0AA3
1FK7084-3BC7	80	2,000	20	8.5	15	6.7	99	9	6SL3120-1TE21-0AA3
1FK7084-3BF7	80	3,000	20	12.1	10	6.5	99	18	6SL3120-1TE21-8AA3
1FK7100-3BC7	100	2,000	18	8.4	14.5	7.1	87	9	6SL3120-1TE21-0AA3
1FK7101-3BC7	100	2,000	27	12.3	20.5	9.7	127	18	6SL3120-1TE21-8AA3
1FK7101-3BF7	100	3,000	27	18.8	15.5	11.6	127	18	6SL3120-1TE21-8AA3
1FK7103-3BC7	100	2,000	36	14.4	25	11	168	18	6SL3120-1TE21-0AA3
1FK7103-3BF7	100	3,000	36	26	14	11.5	168	30	6SL3120-1TE23-0AA3
1FK7105-3BC7	100	2,000	48	20	37	16	249	30	6SL3120-1TE23-0AA3

*) For further Power/Motor Modules for SINAMICS S110/S120 see Catalogs PM 21, NC 61 or SIZER for Siemens Drives configuration tool
 **) Preferred types with 10 days delivery time ex works (AM20DQ1, AS20DQ1 and AM15DQ can be selected)

Siemens AG
 Industry Sector
 Drive Technologies Division
 Motion Control Systems
 Postfach 31 80
 91050 ERLANGEN
 GERMANY

www.siemens.com/servomotors

Subject to change without prior notice
 Article No.: 6ZB5711-0AT02-0AA3
 E.9114.24.VKT / Dispo 18401
 BR 1113 2. SB 8 En
 Printed in Germany
 © Siemens AG 2013

The information provided in this brochure contains merely general descriptions or characteristics of performance which in case of actual use do not always apply as described or which may change as a result of further development of the products. An obligation to provide the respective characteristics shall only exist if expressly agreed in the terms of contract. Availability and technical specifications are subject to change without notice.

All product designations may be trademarks or product names of Siemens AG or supplier companies whose use by third parties for their own purposes could violate the rights of the owners.